

Grumman Body Parts Quick Reference Guide

Notes:

**ALUMINUM Z-POST 332-2D, E
USED WITH FP4000R&L CORNER
CAPS.**

**STEEL Z-POST 732-2D, E USED
WITH FP4500R&L CORNER CAPS
& FP4100R&L**

DISCLAIMER

USE OF OEM OR MANUFACTURERS' NAME AND/OR PART NUMBERS IS FOR IDENTIFICATION PURPOSES AND SIMPLIFICATION ONLY AND IN NO WAY IS MEANT TO IMPLY THAT FLEET PARTS' ITEMS ARE AUTHORIZED OR IN ANY WAY AFFILIATED WITH THOSE MANUFACTURERS.

Part 01021- Grumman Vertical Connector

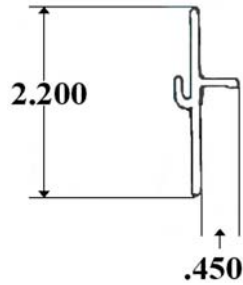

**Used only with FP4100R & L
Plastic Corner Caps**

OEM # 001481

Part 01026- Grumman Horizontal Connector

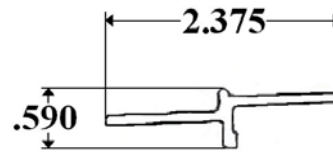

**Used only with FP4100R & L
Plastic Corner Caps**

OEM # 6900146

Part 1014M- Corner Radius Grumman

M-Mill

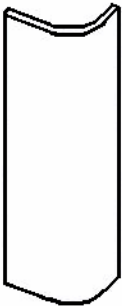

1014M 16.687 X 96"
1014M/102 16.687 X 102"

**Used only with FP4100R & L
Plastic Corner Caps**

**Part 332-2D (97"), 2E (108") & 2F (112")-
Aluminum Z-Post Grumman**

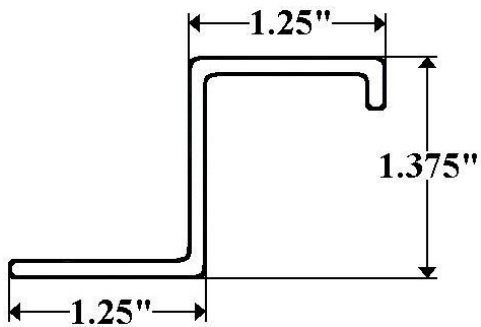

Used with FP4000R&L Corner Caps

Part 4002- Top Rail Grumman

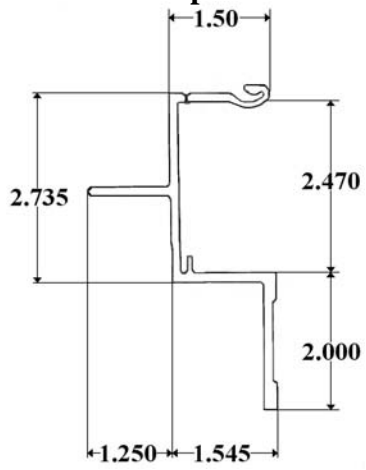

Use with Interlock

Part 4003- Bottom Rail Grumman

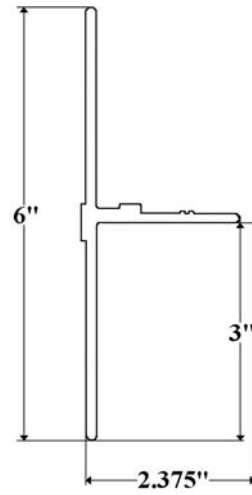

Interlock for Grumman Top Rail

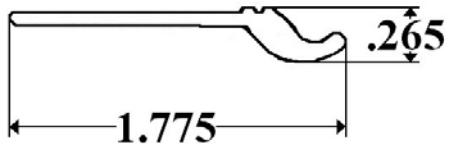

Use with 4002 Top Rail

Part 4012/102- Grumman Roof Radius

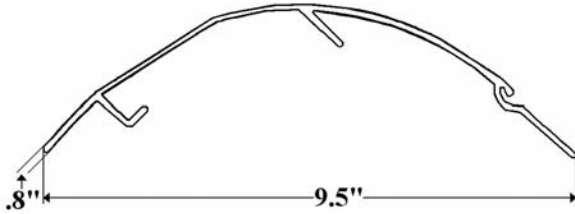

Used with FP4500R&L Corner Caps

**Part 4012L- Grumman Roof Radius
Lower of 2 Pieces (Upper #4012U)**

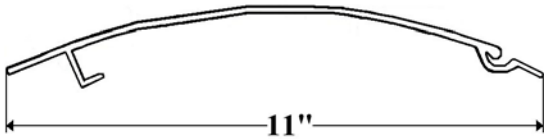

Used with FP4000R&L Corner Caps

**Part 4012M (Mill),
4012PY (Penske Yellow)-
Grumman Roof Radius**



Used with FP4100R&L Corner Caps

**Part 4012U- Grumman Roof Radius
Upper of 2 Pieces (Lower #4012L)**

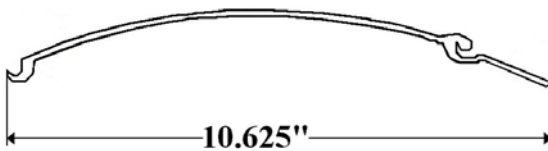

Used with FP4000R&L Corner Caps

**Part 419-1D (92.5) & 419-1E (98.5)-
Roof Bow Grumman**

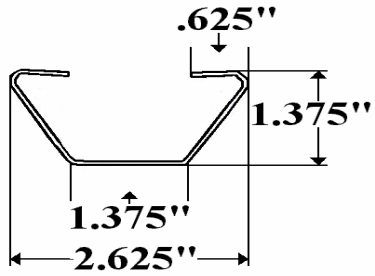

**Part 4030/103 (103.5") & 4030/112 (112")-
Corner Post Grumman**

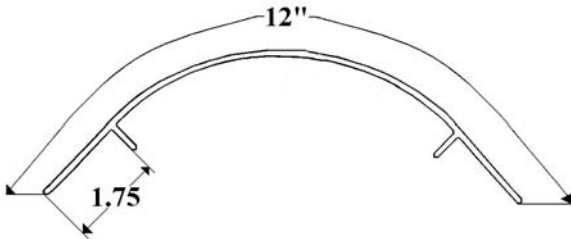

**Part 732-2D (96"), 2E (108") & Punched
732-NH (No Holes) for FRP Bodies-
Grumman Steel Z-Post**

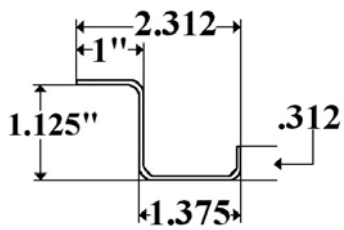

Used with FP4500R&L Corner Caps

**Part FP4000AF- Grumman
Rear Corner Cap**



**Part FP4000L- Grumman
Left/Front Cap**

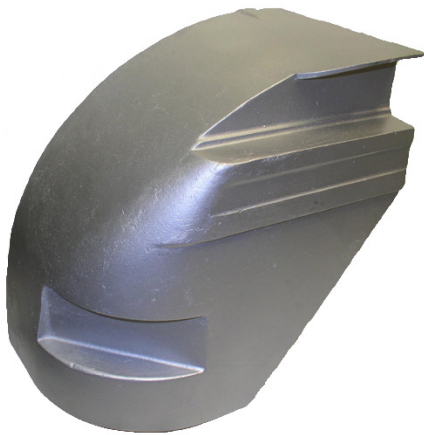

**Part FP4000R- Grumman
Right/Front Cap**

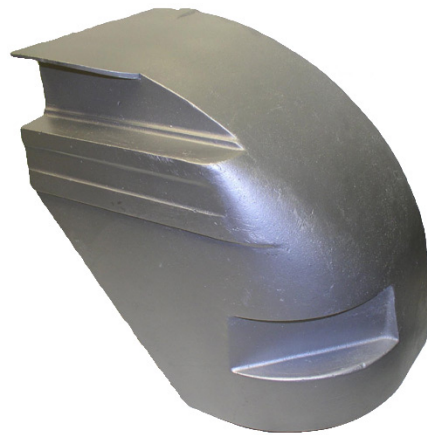

**Part FP4100L- Grumman Left/Front
Plastic Cap**



**Part FP4100R- Grumman Right/Front
Plastic Cap**



**Part FP4500L- Grumman
Left/Front Cap**



**Part FP4500R- Grumman
Right/Front Cap**



**Part FP4510L- Grumman
Left/Front Cap**



Grumman Family Van

**Part FP4510R- Grumman
Right/Front Cap**



Grumman Family Van

Part GR1- Grumman Rear Header

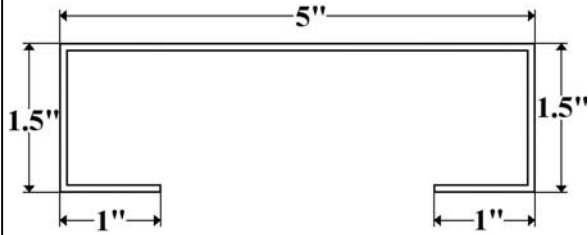

Part GR2- New Grumman Rear Header

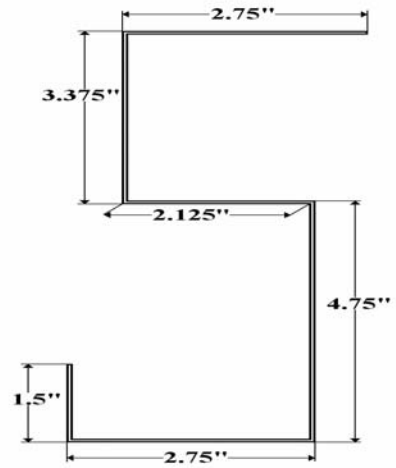

Part GR3 (108'')- Grumman Rear Corner Post

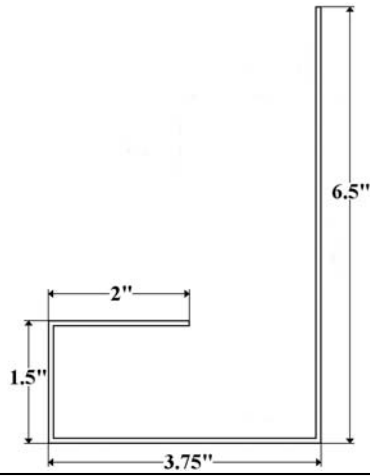

Part GR3-1 (108'')- Grumman Rear Corner Post

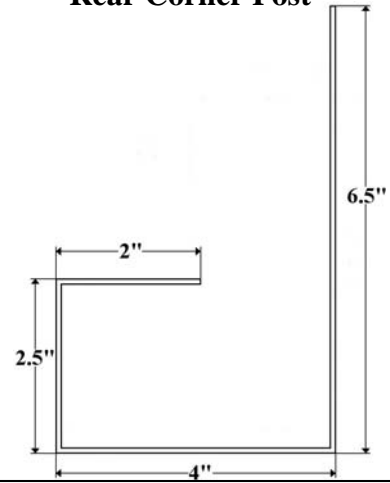

**Part S5022-Front Vertical Connector
Grumman Aluminum Body**

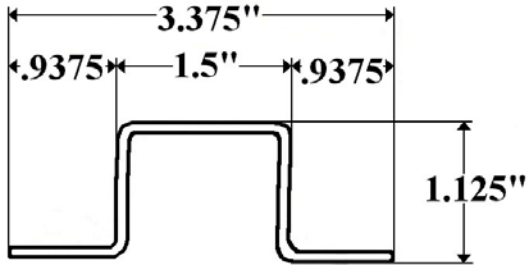

T-Nut

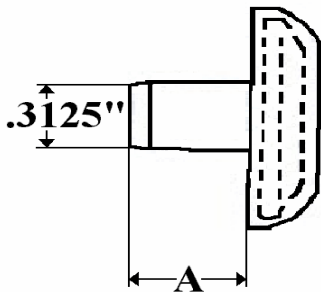

- 5/16-18 X 7/16" Grey
- 5/16-18 X 7/16" White
- 5/16-18 X 5/8" White

T-Nut Bolt

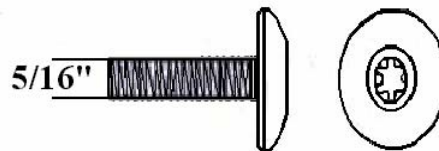

- 5/16-18 X 1/2" Torx HD
- 5/16-18 X 3/4" Torx HD
- 5/16-18 X 1" Torx HD

All with Patch
Uses TX 40 Bit