

**Utilimaster
Body Parts
Quick
Reference
Guide**

Notes:

DISCLAIMER

USE OF OEM OR MANUFACTURERS' NAME AND/OR PART NUMBERS IS FOR IDENTIFICATION PURPOSES AND SIMPLIFICATION ONLY AND IN NO WAY IS MEANT TO IMPLY THAT FLEET PARTS' ITEMS ARE AUTHORIZED OR IN ANY WAY AFFILIATED WITH THOSE MANUFACTURERS.

**Part 00010 (96'') & 00010/108 (108'')-
Steel Slat Spacer FRP Body**

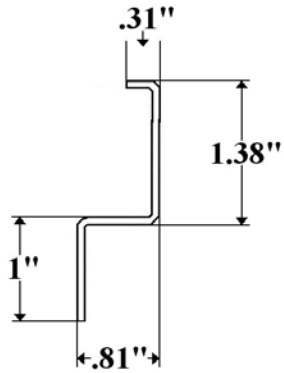

**Part 03020R&L-Utilimaster Vertical
Connector Aluminum Body 108''**

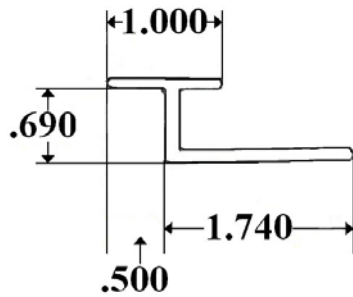

**Please Specify Right or Left
03020L OEM # 06918985
03020R OEM # 06918987**

Part 3002- Utilimaster Top Rail

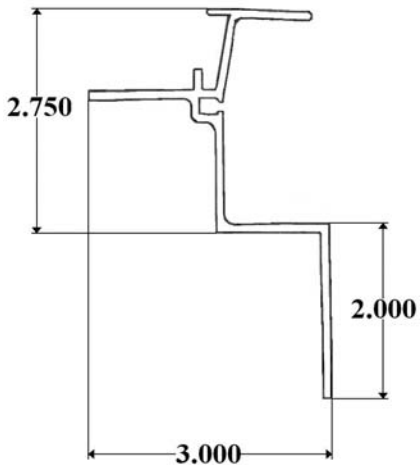

**Part 3003- Utilimaster Bottom Rail
*Thru 1/98***

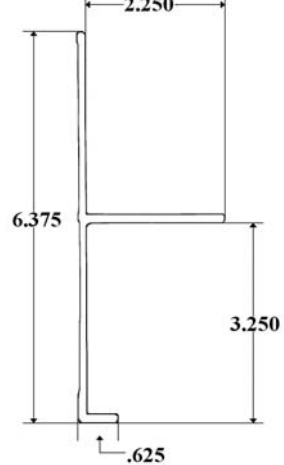

Part 3004- Utilimaster Bottom Rail
From 2/98

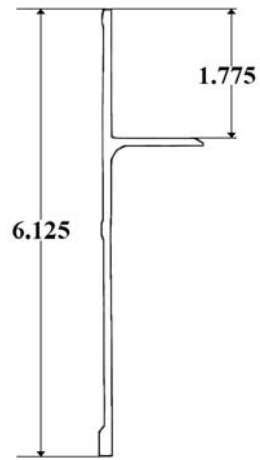

Part 3005- Utilimaster Bottom Rail
New Style

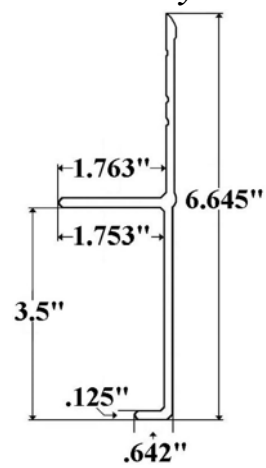

Part 3007- Utilimaster Top Rail New Style

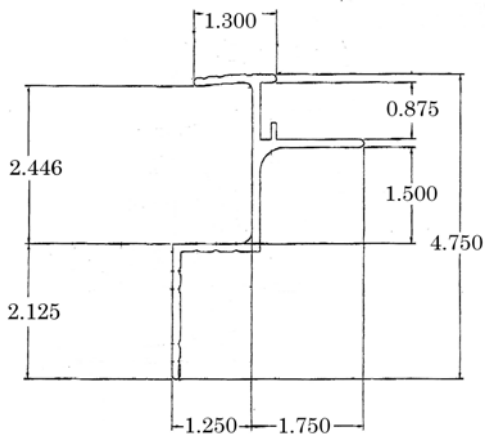

Part 3009- Utilimaster Rear Top Rail

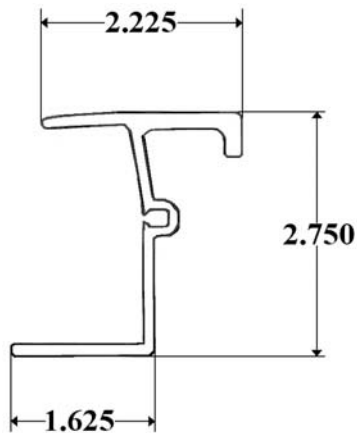

Utilimaster Roof Radius *Mitred*

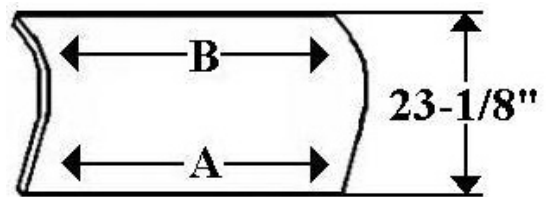

	A	B	
3012RY	80"	X 88-1/2	Ryder Yellow
3012M	84"	X 92-1/2	Mill
3012M2	90"	X 98-1/2	Mill

**Part 3050/92.5 (92.5'') & 98.5 (98.5'')-
Starter Bow Utilimaster**

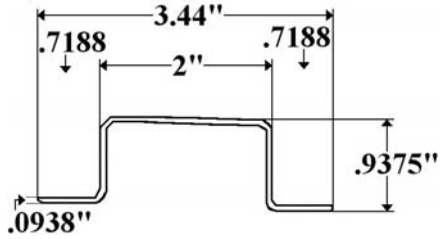

**Part 321-1C (88.5''), 1D (92.5'') &
321-1E (98.5'')-
Roof Bow Utilimaster**

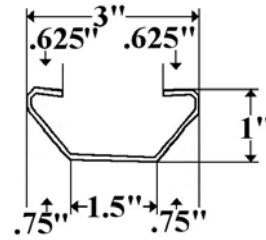

**Part 330-2D (96'')- Utilimaster
Steel Z-Post Aluminum Body 1998**

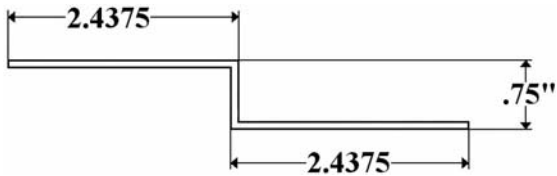

Utilimaster Corner Radius

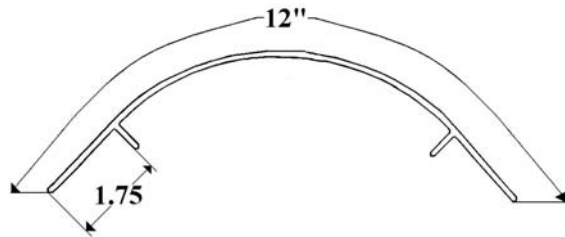

4030/103	12''	X	103.5''	Extruded
4030/112	12''	X	112''	Extruded

**Part 732-2D (96'') & 2E (108'')-
Utilimaster Steel Z-Post Aluminum Body**

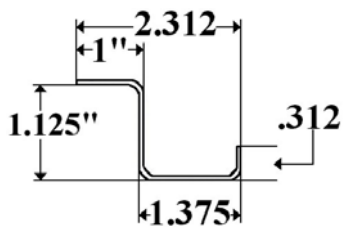

**Part CGS- Utilimaster 1/4 H.D. Steel
Corner Gusset**

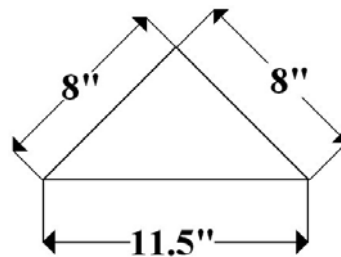

SQUARE CORNER HINGE

No. 4040

Square corner rear door hinge. All steel, this hinge allows door to swing 270° for full opening. Supplied with non-removable pin. (Removable pin also available). Universal for right or left hand doors. Available Flush to 1/2" Offset.

Specifications:

Bracket: 8 ga x 5" x 4-1/2" Wide

Strap: 8 ga x 1-3/4" x 12-1/8" Long

Pin: 1/2" Dia.

Finish: Zinc plated

Weight: 3-3/4 lbs.

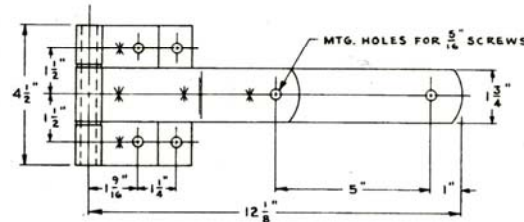
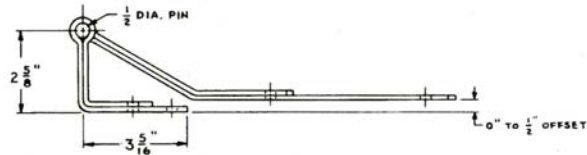
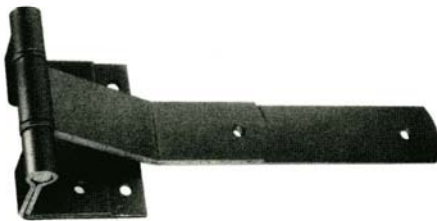

Part 732-2D (96") & 2E (108")-
Utilimaster Steel Z-Post Aluminum Body

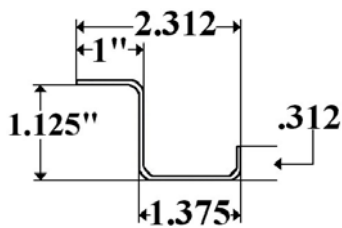

Part CGS- Utilimaster 1/4 H.D. Steel
Corner Gusset

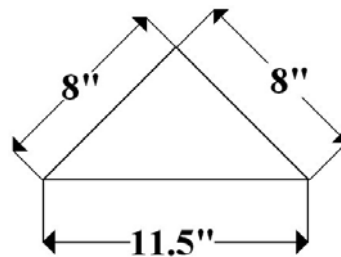

Part FP3000AF– Utilimaster Rear Cap



**Part FP3000L– Utilimaster
Left/Front Cap**



**Part FP3000R– Utilimaster
Right/Front Cap**



**Part FP3100L– Utilimaster
Left/Front Corner Cap *New Style***



**Part FP3100R– Utilimaster
Right/Front Corner Cap *New Style***



Part GR2- New Utilimaster Rear Header

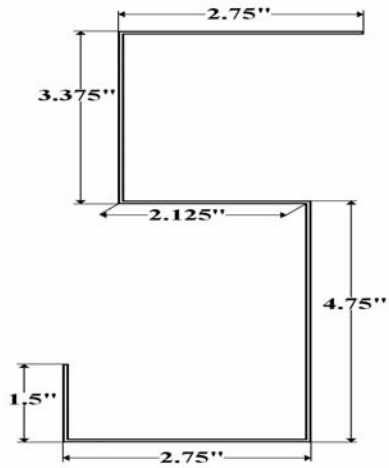

Part UT1- Utilimaster Rear Header

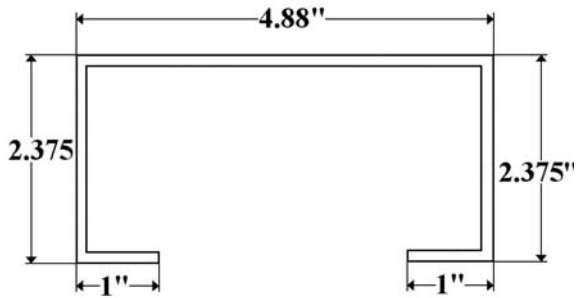

Part UT3 (108")- Utilimaster Rear Corner Post

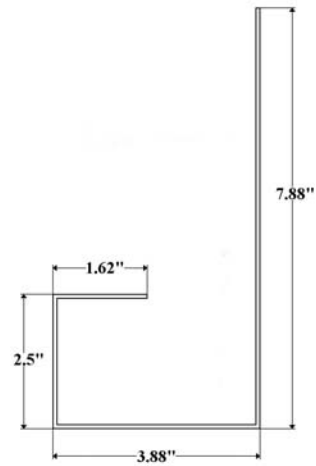

FULL LINE OF:

- **FASTENERS**
- **HARDWARE**
- **SEALANTS**
- **FRP**
- **ROOFING**
- **PANELS**
- **TOOLS**
- **DOORS & PARTS**